

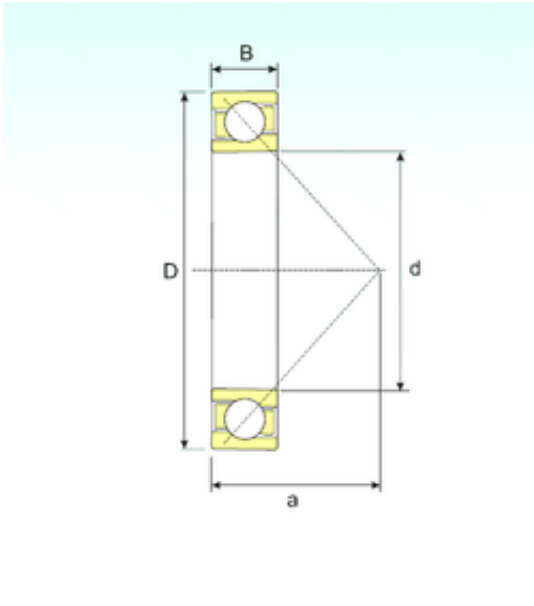

FAG BEARING LIMITED



7203 B Bearing 2D drawings and 3D CAD models

17 mm x 40 mm x 12 mm ISB 7203 B angular contact ball bearings

Bearing No. 7203 B

Size	17x40x12 mm
Bore Diameter	17 mm
Outer Diameter	40 mm
Width	12 mm
d	17 mm
D	40 mm
B	12 mm
C	12 mm
a	18 mm
Weight	0,064 Kg
Basic dynamic load rating (C)	10,88 kN
Basic static load rating (C0)	5,98 kN
(Grease) Lubrication Speed	15300 r/min