

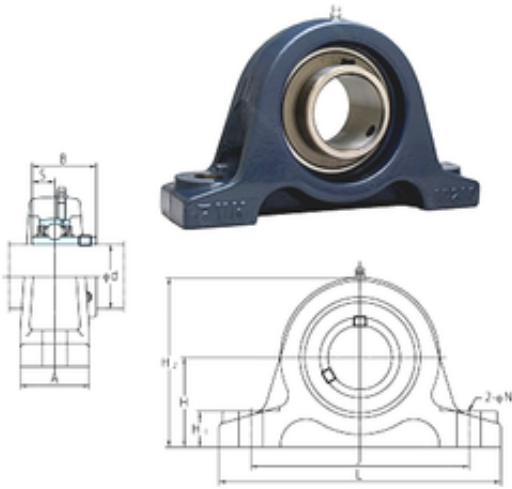

# FAG BEARING LIMITED

## FYH UCIP315-48 bearing units

Bearing No. UCIP315-48



UCIP315-48 Bearing 2D drawings and 3D CAD models

Bore Diameter	76,2 mm
Width	82 mm
d	76,2 mm
A	75 mm
B	82 mm
H	120 mm
H1	35 mm
H2	230 mm
J	280 mm
L	340 mm
N	25 mm
S	32 mm
Bolt (G)	M22
Weight	17,6 Kg
Basic dynamic load rating (C)	113 kN
Basic static load rating (C0)	77,2 kN